



Vertikallamellen & Baffeln

## MINERAL Baffle Element

(OPTIMA Baffle)













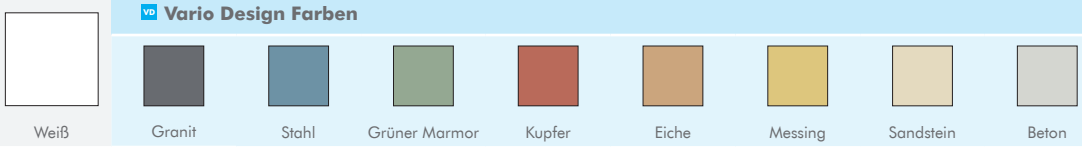

Einzel / Zusammengesetzt



- MINERAL Baffle Element umfasst eine Reihe von leistungsstarken akustischen Baffeln mit einer vliesbeschichteten weißen Oberfläche, die für ein modernes, geradliniges Erscheinungsbild sorgt.
- Gute Schallabsorption: Reduzieren den Geräuschpegel, erhöhen die Verständlichkeit und verringern die Nachhallzeit im Raum.
- Eingesetzt in akustisch anspruchsvollen Bereichen, wie Büros, Freizeiteinrichtungen, Wartezonen etc.



Vertikallamellen & Baffeln  
**MINERAL Baffle Element**  
 Einzeln / Zusammengesetzt

<b>Dicke (mm)</b>		39															
<b>Abmessungen (mm)</b> Weitere Kantenausführungen auf Anfrage		1200 x 300 1200 x 400	1800 x 300 1800 x 400														
<b>System</b>		Abhängeset															
<b>Gewicht</b>		1200 x 300: 3.8 kg/Stk 1200 x 400: 5.0 kg/Stk	1800 x 300: 5.6 kg/Stk 1800 x 400: 7.5 kg/Stk														
<b>Farbe &amp; Design</b>		 <p><b>vd Vario Design Farben</b></p>															
<b>Schallabsorption</b>		EN ISO 354 $\alpha_w = \mathbf{0.50(MH)}$ (300mm) gemäß EN ISO 11654 - <b>Klasse D</b> <table border="1"> <thead> <tr> <th>Frequenz f (Hz)</th> <th>125</th> <th>250</th> <th>500</th> <th>1000</th> <th>2000</th> <th>4000</th> </tr> </thead> <tbody> <tr> <td>Baffeln 1200 x 300 mm <math>\alpha_p</math> Reihenabstand 300 mm</td> <td>0.15</td> <td>0.25</td> <td>0.45</td> <td>0.90</td> <td>0.90</td> <td>0.95</td> </tr> </tbody> </table> NRC = <b>0.65</b> (300mm) gemäß ASTM C 423		Frequenz f (Hz)	125	250	500	1000	2000	4000	Baffeln 1200 x 300 mm $\alpha_p$ Reihenabstand 300 mm	0.15	0.25	0.45	0.90	0.90	0.95
Frequenz f (Hz)	125	250	500	1000	2000	4000											
Baffeln 1200 x 300 mm $\alpha_p$ Reihenabstand 300 mm	0.15	0.25	0.45	0.90	0.90	0.95											
<b>Brandverhalten</b>		Euroklasse <b>A2-s1,d0</b> gemäß EN 13501-1															
<b>Lichtreflexion</b>		<b>88%</b>															
<b>Feuchtigkeitsbeständigkeit</b>		<b>90%</b>															
<b>Luftqualität</b>																	
<b>Reinigung</b>																	
<b>Nachhaltigkeit</b>																	

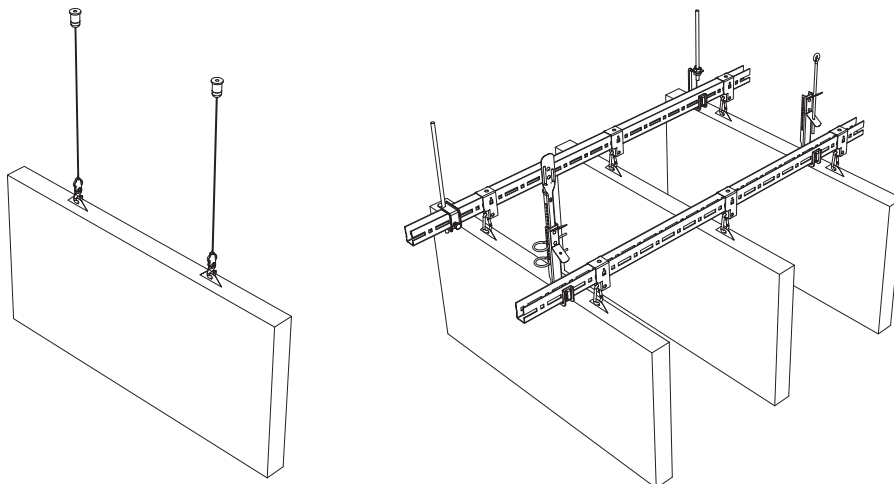

**vd** Optionen mit diesem Symbol sind in unserem **Vario Design** Sortiment erhältlich.  
 Die Produktverfügbarkeit kann sich von Land zu Land unterscheiden.  
 Für weitere Informationen wenden Sie sich bitte an Ihren persönlichen Vertriebsansprechpartner.  
 Weitere Informationen und rechtliche Hinweise finden Sie auf unserer Website.  
[knaufceilingsolutions.com](http://knaufceilingsolutions.com)